

膜片式液泵 Oil-Free Diaphragm Pumps for Liquid

DLP200DC 系列(Series DLP200DC)

特点 Features

无油润滑 Oil-Free
耐腐蚀性 Corrosionresistant
免维护 Maintenance Free
低噪音低振动 Low noise level&vibration
可以任何方向安装 Can be mounted in any plane
自吸功能 Self priming

结构紧凑 Compact size
长寿命 Long life
重量轻 Low Weight
低功耗 High efficiency
直流电机 DC Models
可以干转 Dry running

应用 Typical Applications

生化仪 Bio-Chemical Analyzer
实验室设备 Lab equipment
洗板设备 Microplate Washer
环境检测 Air Sampler
消毒柜 Autoclave
医疗设备 Medical Applications
液体分析 Liquid Analytical
冷却设备 Cooling and Heating

污水处理 Sewage disposal
喷绘打印 Wide-Format Printer
生化仪 Bio-Chemical Analyzer
电解质 Electrolyte
美容设备 Beauty equipment
化学分析 Chemistry analysis
工业应用 Industrial Applications
打印设备 Printing systems (ink)



可根据客户使用要求定做: We can design according to customer requirements

技术参数 Technical Data

额定电压 Rated voltage	DC6V	DC12V	DC24V
额定电流 Rated current	0.8A	0.4A	0.2A
空载流量 Free flowing	180mL/M	180mL/M	180mL/M
扬程 Max Press. Height	10m WC	10m WC	10m WC
最大吸力 Max Suction Height	3m WC	3m WC	3m WC
使用温度 Ambient temperature	0- 40°C	0- 40°C	0- 40°C
重量 Weight	63g		

- 可以在任何方向安装使用 Can be mounted in any plane
- 真空和压力均可 applicable as vacuum pump or pressure pump

材质: Parts in contact with medium Option

- 泵头 Pump head: PPS
- 膜片/阀片 Diaphragms, valves: EPDM



外形尺寸: Dimensions(mm)

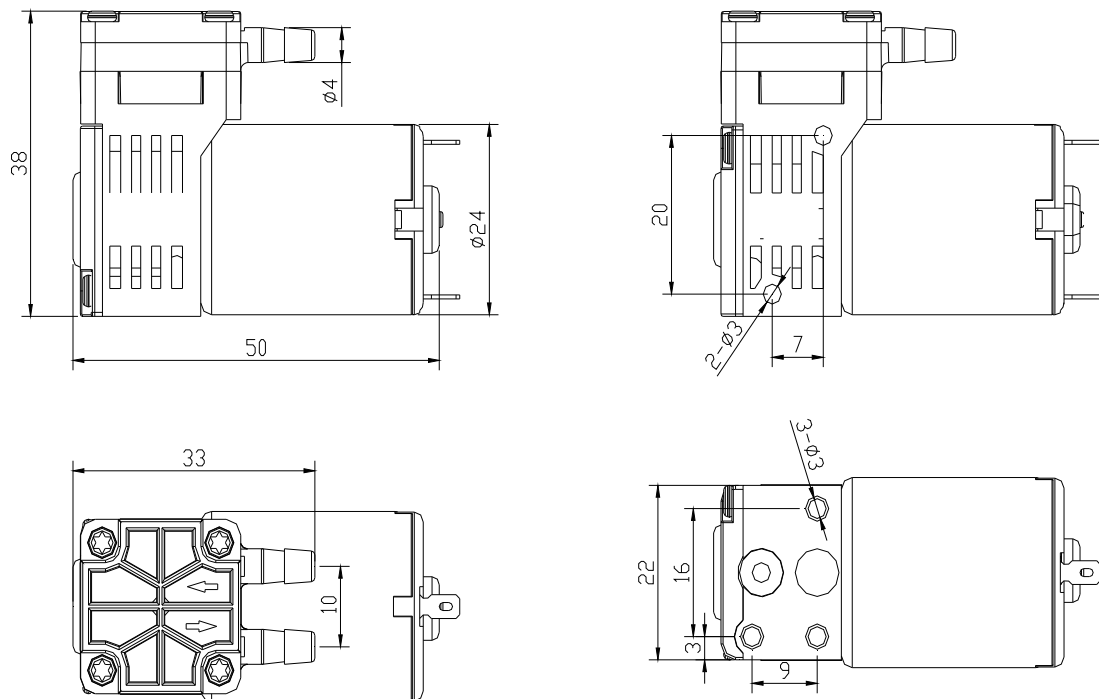

可根据客户使用要求定做: We can design according to customer requirements